

## **XP4 WALK-IN DUCTED FUME CUPBOARD**

### **OPERATORS MANUAL**



**Issue 02 – September 2021**

**SafeLab Systems Ltd**

Airone Building, 8 Beaufighter Road, Weston-Super-Mare, BS24 8EE

Tel: +44 (0) 1934 421 340 | Email: [safelab@safelab.co.uk](mailto:safelab@safelab.co.uk) | Web: [www.safelab.co.uk](http://www.safelab.co.uk)

Registered in England & Wales N° 5336826



Designed & Manufactured  
in the UK



## CONTENTS

### SECTION 1

1.1.	FOREWORD .....	4
1.2.	WARNING NOTICES .....	5
1.3.	PRECAUTIONS.....	5
1.4.	GENERAL OPERATING CONDITIONS .....	5
1.5.	ENVIRONMENTAL CONDITIONS. ....	5
1.6.	ELECTRICAL SAFETY .....	6
1.7.	SAFETY NOTICE .....	6
1.8.	ENVIRONMENTAL PROTECTION .....	7
1.9.	INTRODUCTION .....	7
1.10.	PRINCIPLES OF OPERATION .....	8
1.11.	IMPROPER USE. ....	9
1.12.	GUIDELINES FOR SAFE USE.....	9

### SECTION 2

2.1.	SPECIFICATION .....	10
2.2.	SPECIFICATION DIAGRAM .....	11

### SECTION 3

3.1.	OPTIONAL FEATURES.....	12
3.2.	INSTALLATION AND ASSEMBLY .....	12
3.3.	LOCATION OF FUME CUPBOARD.....	13
3.4.	CONNECTIONS (Gas and Water are optional) .....	14

### SECTION 4

4.1.	OPERATING INSTRUCTIONS.....	15
4.2.	CONTROL PANEL FEATURES .....	16
4.3.	DISPLAY FEATURES .....	17
4.4.	CONTROL PANEL OPERATION .....	17
4.5.	AIRFLOW INDICATOR .....	18
4.6.	FAN FAIL ALARM.....	18
4.7.	HIGH SASH ALARM .....	19
4.8.	VAV DAMPER OVERRIDE .....	19



**SECTION 5**

5.1. LIGHT SWITCH ..... 20

5.2. ELECTRICAL SOCKETS (*Optional*) ..... 20

5.3. SERVICES (*Optional*) ..... 20

5.4. PIR SENSOR (*Optional*) ..... 20

**SECTION 6**

6.1. WIRING DIAGRAMS ..... 21

6.2. MAINTENANCE AND PERFORMANCE MONITORING:..... 23

6.3. SPILLAGES ..... 24

6.4. SPARES PARTS ..... 24

6.5. NOTES (left blank for notes) ..... 25

**CERTIFICATE OF CONFORMITY .....26**



## 1. SECTION 1

### 1.1. FOREWORD

This manual has been prepared to give guidance in the use of your Airone XP4 Walk-in Ducted Fume Cupboard.

It is recommended that service and maintenance operations should only be undertaken by SAFELAB Service Engineers or their authorised agents.

Details of Service Contracts/Programmes, along with further information on our range products, are available on request from:

Airone Building  
8 Beaufighter Road  
Weston-Super-Mare  
BS24 8EE

Telephone - +44 (0)1934 421340  
E-mail - safelab@safelab.co.uk  
Website: - <http://www.safelab.co.uk>

#### NOTE:

**This Fume Cupboard will require an inspection and test under COSHH regulation 9 by a suitably qualified engineer.**

We recommend that this Fume Cupboard is examined and tested annually, in order to be compliant with regulation 9.2.a at all times.

COSHH Regulation 9 Maintenance, Examination and Testing of Control Measures

(2) Where engineering controls are provided to meet the requirements of regulation 7, the employer shall ensure that thorough examination and testing of those controls is carried out

(a) in the case of local exhaust ventilation plant, at least once every 14 months.

## 1.2. WARNING NOTICES

Within this User Manual WARNINGS are used to highlight information or instructions that **must** be followed in order to avoid personal injury to yourself or other people in the vicinity, eg. switch off the mains voltage before any maintenance.

WARNINGS appear as below:

 <b>WARNING</b>	Switch off the mains voltage and remove the mains cord before maintenance.
---	--

## 1.3. PRECAUTIONS

The following precautions must be observed when using the Fume Cupboard:

- Be sure that the voltage of the Fume Cupboard corresponds to the voltage available where it is to be installed
- Never remove the side or front covers of the Fume Cupboard without first isolating the equipment and disconnecting the mains cord

## 1.4. GENERAL OPERATING CONDITIONS

The Fume Cupboard has been designed and tested in accordance with the safety requirements of the International Electrotechnical Commission (IEC). The Fume Cupboard conforms to IEC61010-1 (Safety Requirements for electrical equipment for measurement, control and laboratory use) as it applies to IEC Class 1 (earthed) appliances, and therefore meets the requirements of Low Voltage Directive 2014/35/EU.

If possible, avoid any adjustment, maintenance or repair to the equipment whilst covers are open or it is in operation. However, if any adjustment, maintenance or repair is necessary while the covers are open, this must be done by a competent person who is aware of the hazards involved.

## 1.5. ENVIRONMENTAL CONDITIONS.

This Fume Cupboard should only be used under the following conditions:

- Indoor-use only
- Must be connected to a suitable extract system
- Unit to be sited away from the influence of draughts
- Electrical supply fluctuation not exceeding +10% of the nominal voltage
- In ambient temperatures between 5°C and 40°C
- With relative humidity below 80% for temperatures up to 31°C, decreasing linearly to 50% relative humidity at 40°C

 <b>WARNING</b>	The protection provided by the equipment may be impaired if the environmental conditions do not lie within these parameters.
---	--

### 1.6. ELECTRICAL SAFETY

The Fume Cupboard is designed to protect the user from potential electrical hazards. This section describes some recommended electrical safety practices.

 <b>WARNING</b>	<p>Lethal voltages are present at certain points within the equipment. When the equipment is connected to mains power, removing the equipment covers is likely to expose live parts. Even when the power switch is off, high voltages can still be present – capacitors within the equipment may still be charged even if the equipment has been disconnected from all live voltage sources.</p>
---	--

The Fume Cupboard and associated equipment must be correctly connected to a suitable electrical supply. The supply must have a correctly installed protective conductor (earth or ground) and must be installed and checked by a qualified electrician before initial power up.

 <b>WARNING</b>	<p>Any interruption of the protective conductor inside or outside of the Fume Cupboard, or disconnection of the protective conductor terminal, is likely to make the equipment dangerous. Intentional interruption of the protective conductor is prohibited.</p>
---	---

 <b>WARNING</b>	<p>If the mains power cord has to be replaced, ensure that the replacement cord is appropriately rated and approved for the intended use.</p>
---	---

 <b>WARNING</b>	<p>To prevent potential personal injury or damage to the equipment, switch OFF all components in the system and disconnect them from the mains power supply before altering or making any new electrical connections.</p>
---	---

### 1.7. SAFETY NOTICE.

This Fume Cupboard must be used in compliance with these instructions and any repairs or maintenance carried out by a competent person.

It is important that you read the instruction manual before first use and keep it in a safe place for future reference.

### DISPOSAL

	<p>Dispose of packaging in an environmentally-friendly manner. This appliance is labelled in accordance with European directive 2012/19/EU concerning used waste electrical and electronic equipment (WEEE). This symbol means the disposal of this equipment must be handled separately from general urban waste. Appropriate disposal of this equipment will help to prevent potential negative effect on the environment and to promote re-use or recycling of materials.</p>
---	--

### **1.8. ENVIRONMENTAL PROTECTION**

Chemical fumes that are extracted through the Fume Cupboard and duct system are exhausted to atmosphere, where they are diluted many times over and have a negligible effect on human health. However, where large volumes of chemicals are being used, additional considerations need to be made for preventing the emission of noxious or offensive substances into the atmosphere, which is a legal requirement under the Environmental Protection Act 1990.

### **1.9. INTRODUCTION**

A Fume Cupboard is a local ventilation device that is designed to conform to BSEN 14175 to limit exposure to hazardous chemical fumes, vapours, gases, dusts, mists and aerosols. This type of laboratory equipment provides a physical barrier between reactions within the Fume Cupboard and the operator and laboratory, by offering a measure of protection against inhalation exposure and chemical spills.

A Fume Cupboard does this by maintaining a negative pressure within the interior of the cabinet to prevent any contaminant from escaping, whilst drawing air in through the sash opening at a constant rate. A face velocity (the speed at which air is drawn into the cabinet) is of importance to the safe and effective operation of a Fume Cupboard. Your XP4 unit should be set to run at 0.5m/sec, with the sash at the maximum safe working height (normally 500mm).

### 1.10. PRINCIPLES OF OPERATION

Air is drawn into the cupboard at the **Front Working Aperture (A)** below the sliding sash at a velocity high enough to ensure containment of any fumes, odours or contaminants given off by the processes carried out within the cupboard.

The fumes from within the cupboard are drawn either upwards as in the case of **lighter-than-air** (vapour density < 1) **fumes (C)** to the **Extract Slot (E)**, or drawn across the work surface to the **Secondary Extract Slot (F)** created by the back baffle, as in the case of **heavier-than-air** (vapour density > 1) **fumes/particulates (D)**.

The combination of **Extract Slots (E) and (F)** ensure that all fumes/particulates are carried by the moving body of air to the **Extract Slot and Duct Transition Adaptor (G)** and on into the **Extract Duct System (H)**.

On a constant air volume unit (CAV) as the sash is lowered air will pass through the bypass grill on the **Front Cover (J)**.

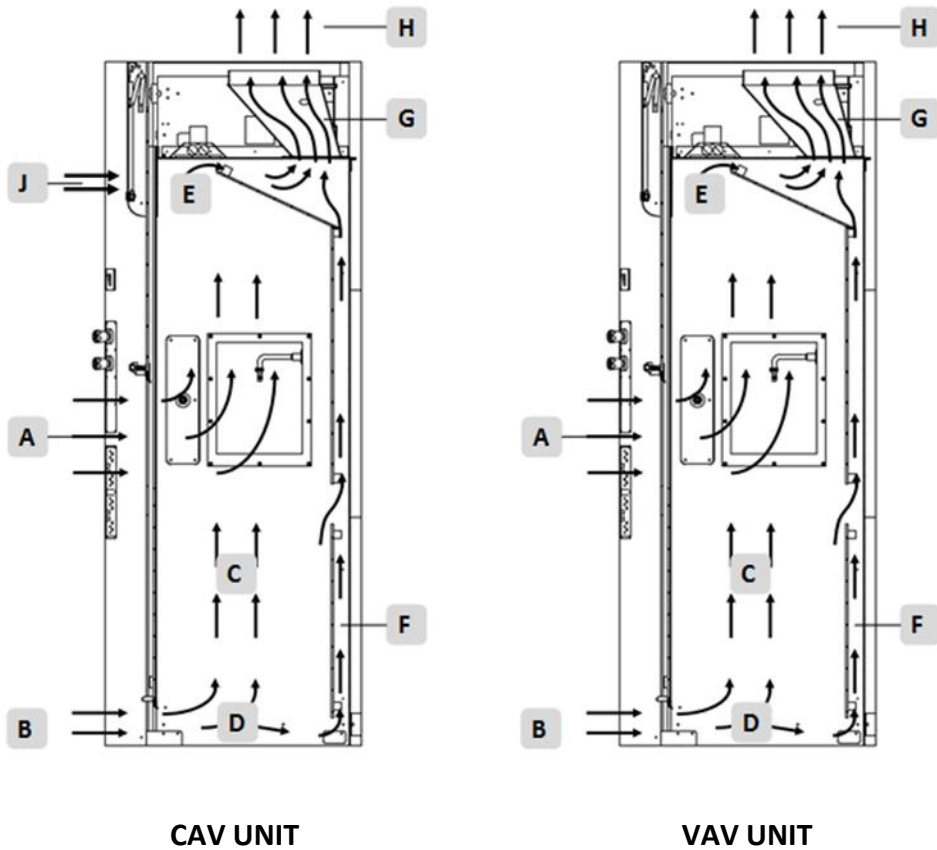



### 1.11. IMPROPER USE.

This Fume Cupboard must be used and operated only in accordance with the user manual, any alterations or disabling of safety features is a violation of the intended use and as a result could cause a danger to person or property.

 <b>WARNING</b>	<p>To prevent potential personal injury and damage to the equipment, the Fume Cupboard must be operated in accordance with the user manual.</p>
---	---

### 1.12. GUIDELINES FOR SAFE USE.

- Only trained personnel should use the Fume Cupboard
- Always follow your standard operating procedure (SOP)
- Only use the Fume Cupboard if it has been serviced within the last fourteen months
- Ensure the extract is working and the display is indicating the unit is safe before commencing work
- When using the Fume Cupboard, never put your head inside the unit. Remember the barrier between clean and contaminated air is the plane of the sash
- Always use the appropriate personal protective equipment (PPE)
- Open windows, doors, fans of air conditioning units and movement of people will all cause airflow disturbance, which can reduce the effectiveness of the Fume Cupboard's containment
- Always work with the sash in the lowest practical position to maximise performance
- Keep the sash closed when not in use
- Keep hazardous chemicals and any reactions at least 15cm behind the plane of the sash
- Report any Fume Cupboard faults immediately
- Close the sash in the event of an electrical power failure
- **Do not** use the Fume Cupboard as a store, even temporarily, for chemical solvents
- **Do not** use the Fume Cupboard as a waste disposal mechanism
- **Do not** remove any panels or covers

**Definition:** The Airone XP4 Walk-in Ducted Fume Cupboard has been designed and tested to meet the containment characteristics requirements of BS EN14175-1:2003 (barring outside influences i.e. building columns and poor siting).

**Application:** Whenever the operator and/or the environment need to be protected from gaseous or particulate contaminants.



## 2. SECTION 2

### 2.1. SPECIFICATION

Model	1.2	1.5	1.8	2.0
Electrical supply:	230V / 50Hz (As standard the unit is fitted with a standard 13A plug top.)			
Installation/overvoltage category:	II			
Pollution degree:	2			
Nominal power cabinet:	70W*		60W*	
Nominal power Aux Sockets	2300W**		2300W**	
Weight	200kg	230kg	260kg	280kg
Inflow	0.5m/s at a maximum working aperture of 500mm			
Lights	LED >690LUX at the work surface		LED >850LUX at the work surface	
Duct connection size	250mm	315mm	315mm	

\*Units without electrical sockets

\*\*Units with electrical sockets option

- Construction:** Main structure, aerofoils and cover panels: Aluminium extrusions or mild steel, painted in epoxy powder coat  
Internal lining, baffles and top panel: High pressure compact laminate (HPL), or to customer specification
- Work tray:** Grey cast epoxy resin as standard, although ceramic work trays are available as an option
- Sash:** The vertical sliding sash is toughened safety glass with an epoxy powder-coated extruded aluminium handle. As standard it is manually operated and suspended by a counterweight  
Maximum working height = 400mm and with Maximum maintenance = 1470mm
- Control Panel:** Digital control system located on the right-hand aerofoil
- Light Switch:** For the integral LED light fitting, this is located on the left-hand aerofoil
- Services:** Optional and to customer specification. (also see connections page 15)

Dimensions including base stand (in millimetres) for standard units:

Unit Model	External (mm)			Internal (mm)			
	Width	Depth	Height	Width	Depth	H. front	H. rear
1200	1200	900	2400*	900	609	2030	1830
1500	1500	900	2400*	1200	609	2030	1830
1800	1800	900	2400*	1500	609	2030	1830
2000	2000	900	2400*	1700	609	2030	1830

\* 2535mm with sash fully open in maintenance height.

## 2.2. SPECIFICATION DIAGRAM

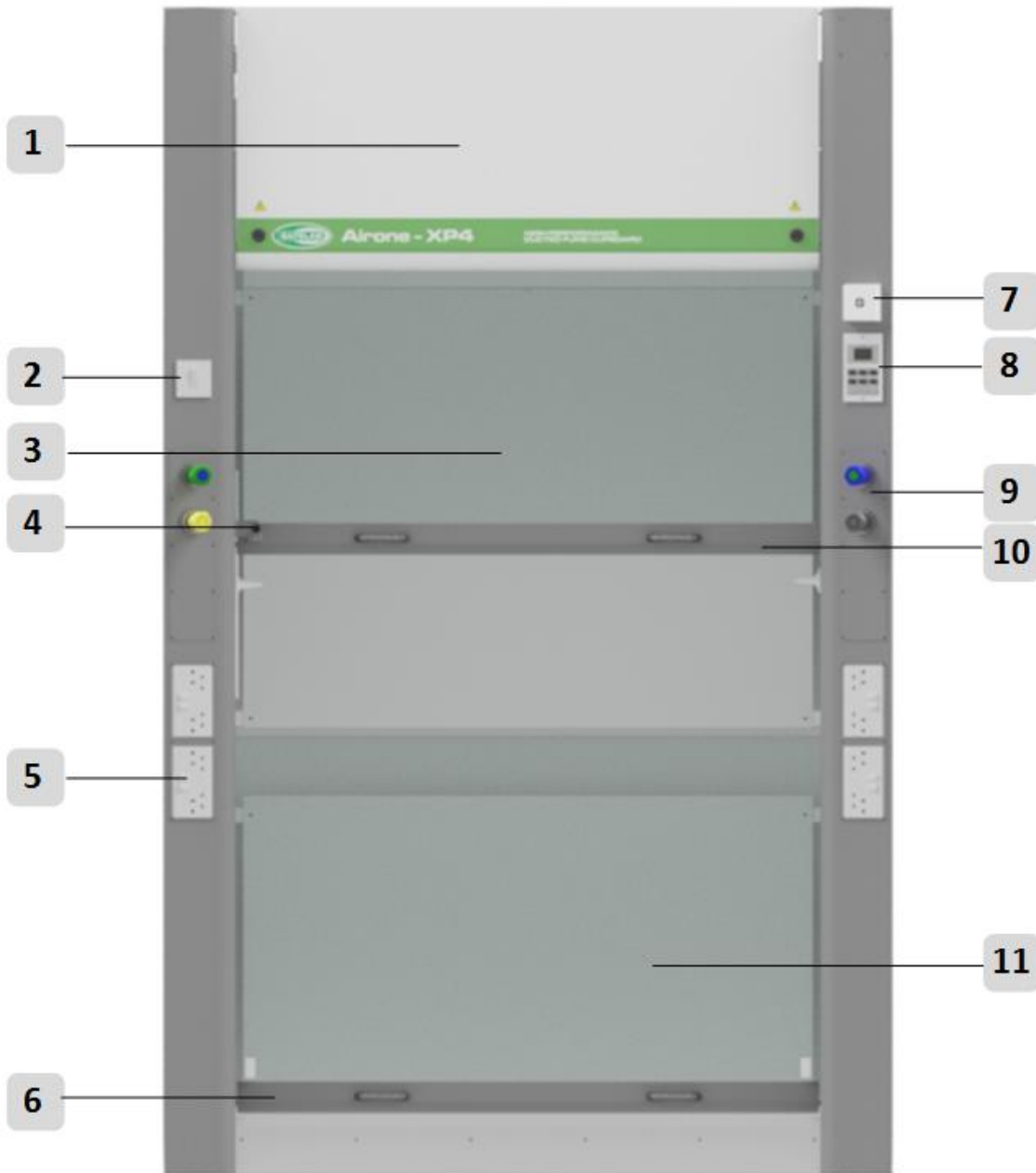

- 1: Hinged top panel
- 2: Light switch
- 3: Rear upper baffle
- 4: Sash stop
- 5: Double sockets (optional)
- 6: Lower sash handle

- 7: Airflow sensor
- 8: Digital controller
- 9: Services (optional)
- 10: Upper sash handle
- 11: Rear lower baffle

### 3. SECTION 3

#### 3.1. OPTIONAL FEATURES

Your unit may be fitted with the following optional features:

- Electrical socket outlets: Maximum of 2 x DSSO can be mounted on each aerofoil
- Services: Liquid & Gas service
- PIR sensor: Unit will alarm if the sash is left open, whilst unattended
- Consumer unit: Where more amperage is required for electrical sockets
- Auto-sash: Motor driven sash, open and closes automatically

#### 3.2. INSTALLATION AND ASSEMBLY

The XP4 Walk-in will be delivered flat-packed and requires assembling on site. The assembly is carried out by the Safelab Engineers.

Space for free air circulation must be provided around the Fume Cupboard (see page 13 for a guide to siting the cupboard).

Your Fume Cupboard was supplied with the follow documentation:

- |                                  |                           |
|----------------------------------|---------------------------|
| - Operational Manual             | - Quality Pass            |
| - Service and Maintenance Letter | - Conformity certificates |
| - Safety Log Book                | - Warranty form           |

### 3.3. LOCATION OF FUME CUPBOARD

Fume Cupboard location should be chosen to minimise any undue airflow disturbances, which will reduce the risk of contaminants leaving the Fume Cupboard and the chances of anomalous results when carrying out the annual inspection test.

A general guide to suitable distances from common airflow disturbances is shown below and if any Fume Cupboards are found to be exposed to these conditions it should be noted in the unit's Log Book.

Further information can be found in BSEN 14175-5:2006 (4.2)

#### GUIDE TO POSITIONING LOCATIONS FOR THE AIRONE XP FUME CUPBOARD

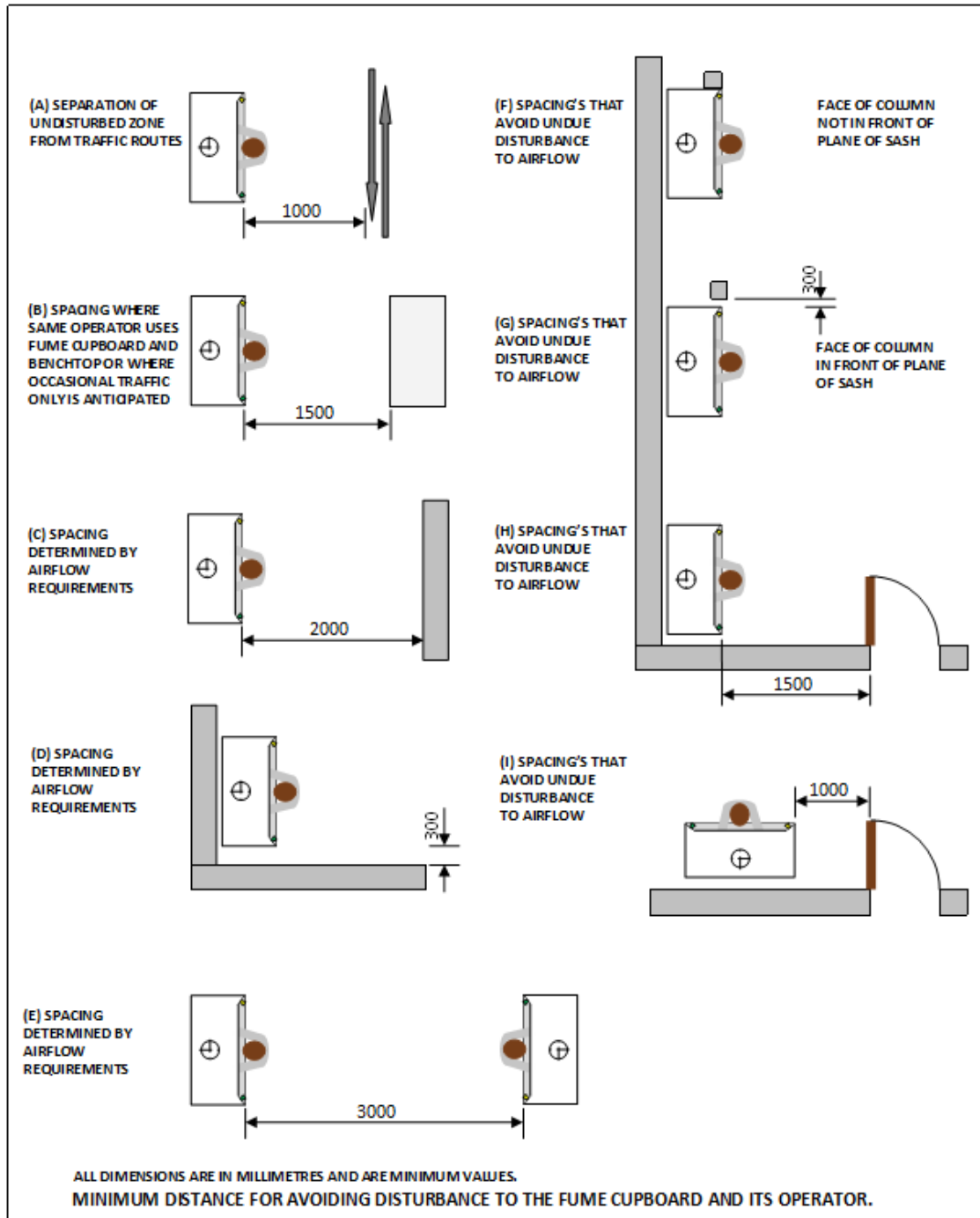

### 3.4. CONNECTIONS (Gas and Water are optional)

Ducting:	Once sited, the Fume Cupboard needs to be connected to the duct extract system Unit duct spigot size: - 1.2 wide unit = $\varnothing$ 250mm - 1.5, 1.8 & 2.0 wide units = $\varnothing$ 315mm
Control system:	The unit control system needs to be connected to the extract fan control system (where applicable)
Water services:	As standard 10mm Nylon hose supplied with push fit fitting, terminating with $\frac{1}{4}$ " male thread, or to customers order specification
Waste:	Supplied with 38mm Vulcathene anti-siphon bottle trap
Natural Gas:	Flexible gas hose terminated with $\frac{1}{4}$ " female thread or to customers order specification (must be connected by a qualified gas safe installer)
Gases non-burning:	As standard 10mm Nylon hose supplied with push fit fitting, terminating with $\frac{1}{4}$ " male thread, or to customers order specification

Once all connections are complete, the Fume Cupboard is now ready for commissioning.

## 4. SECTION 4

### 4.1. OPERATING INSTRUCTIONS

(ENSURE THE UNIT IS PLUGGED IN TO THE MAINS ELECTRICAL SUPPLY)

A Fume Cupboard is only a partial enclosure and cannot provide absolute protection against inhalation of substances used within. In addition, the degree of protection given to the user is dependent on other factors, such as the system of work and the nature of the operations to be performed. For guidance on the risk for particular applications, the purchaser should refer to both the long and short-term exposure limits for airborne chemicals, which are published by the Health & Safety Executive. These limits provide guidance on the levels (in terms of concentration and time) to which exposures to airborne toxic substances should be controlled.

When working with hazardous substances, always consult Safe Systems of Work, which should be provided by your employer.

Position apparatus and materials in the Fume Cupboard so as to minimise disturbance to the airflow at the working aperture and so that it is possible to quickly close the sash without any risk of disturbing the apparatus within.

Always use appropriate PPE (personal protection equipment) when using a Fume Cupboard.

Always close the sash when leaving the Fume Cupboard unattended.

After use, follow the correct procedures for disposal of any residues, and leave the Fume Cupboard in a safe state for further use by others.

## 4.2. CONTROL PANEL FEATURES

### VAV CONTROLLER (Variable Air Velocity)

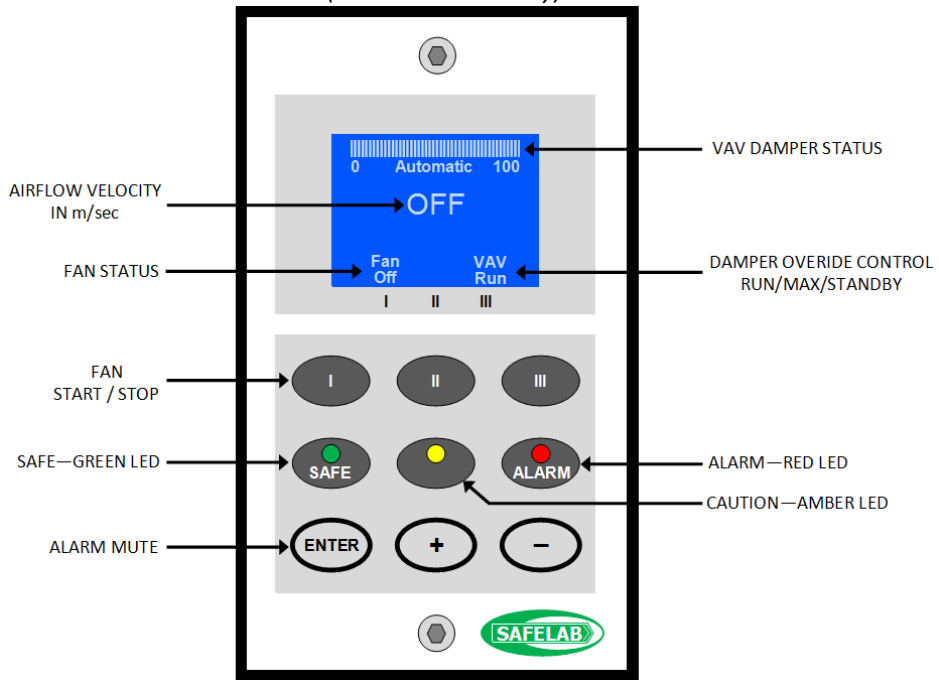

### CAV CONTROLLER (Constant Air Velocity)

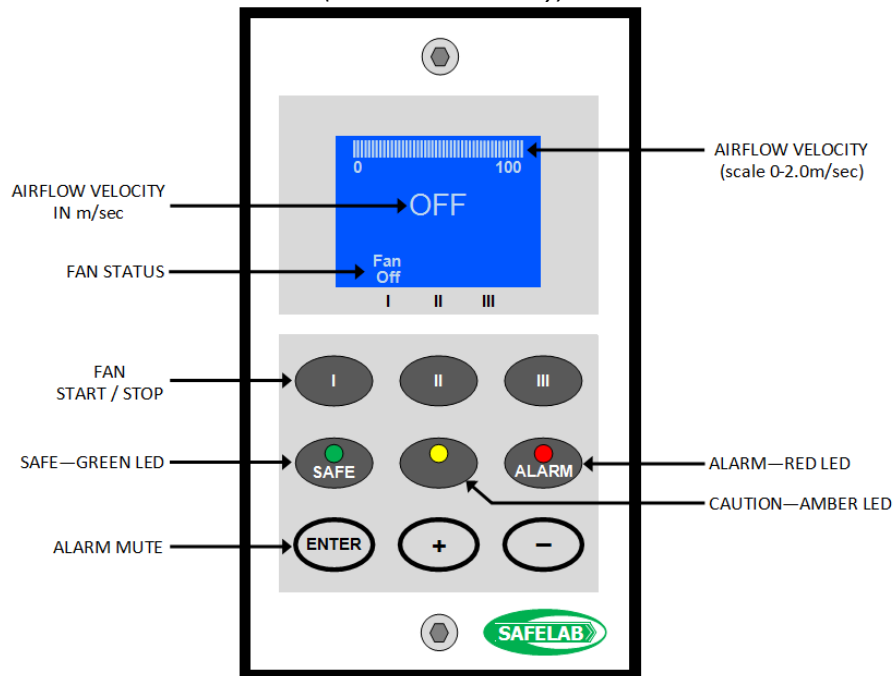



### 4.3. DISPLAY FEATURES

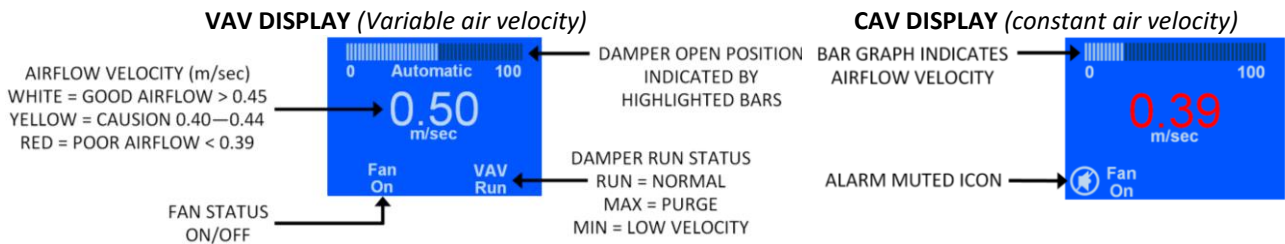

### 4.4. CONTROL PANEL OPERATION

1. Where practical, place any apparatus required inside the Fume Cupboard before commencing process. The design of the cupboard is for the sash opening to be at a maximum normal working height of 500mm from the worktop. To increase safety it is good practice to keep the sash in the closed position as much as possible.
2. With the sash at the maximum working height (normally 500mm) switch on the extract system using the Fan START/STOP Button I (see page 17) from the control panel.

When the FAN START Button is pressed, the fan will switch on and the control screen will display “START UP” as well as counting down from 9 seconds. Note the alarm is muted during this period.

After this period if the fan is not fully up to speed, the display will alternate between the air velocity reading and “AIR FAIL” message. The alarm will sound and the “ALARM” red LED will flash for a very limited time until the fan is up to speed.

Once the fan is up to running speed, 0.5m/sec, the “AIR SAFE” green LED will illuminate. The Fume Cupboard is now ready to use.



- To stop the fan after use, press Button I again and close the sash (*remember to empty the cabinet of all chemicals prior to switching the fan off*).

When the button is pressed, the screen will go into sleep mode and display “OFF”. The “ALARM” LED will flash red and the alarm sound will be muted automatically.

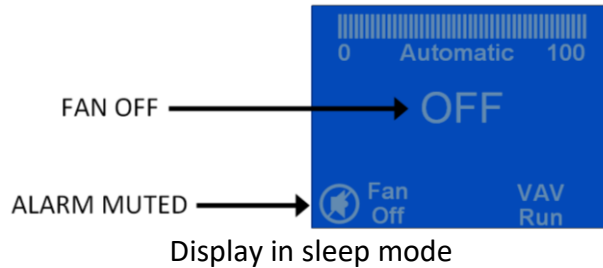

#### 4.5. AIRFLOW INDICATOR

(CAV Screen shown)



##### Low airflow:

- Velocity reading shown in red
- Display alternates between airflow reading and “AIR FAIL” message
- Alarm red LED flashes
- Alarm sounds

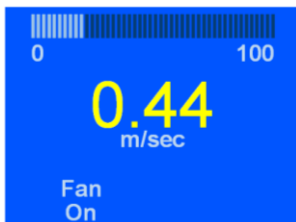

##### Acceptable airflow:

- Velocity reading shown in yellow
- Caution yellow LED flashes

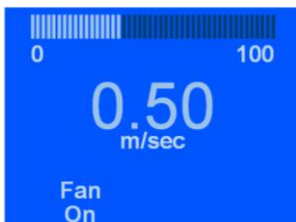

##### Good airflow:

- Velocity reading shown in white
- Safe green LED on

#### 4.6. FAN FAIL ALARM

A failure of the fume extract system will be indicated by the display indicating “AIR FAIL”, a red LED flashing and an audible tone being heard. The air velocity display will also turn red. At this point the sash should be closed to maximise containment. Pressing the “ENTER” button will mute the alarm.

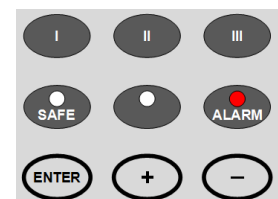
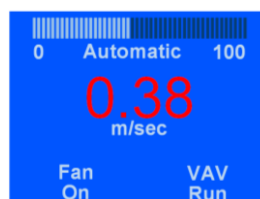

Display alternates between “AIR FAIL” and the velocity reading

Alarm sounds & red LED flashes

#### 4.7. HIGH SASH ALARM

Should you require the sash to be raised above the maximum working height (i.e. for setting up equipment) the sash stop plunger (page 11 item 4) needs to be manually pulled out to allow the sash to move.

If the extract is on and the Fume Cupboard is operated with the sash above the maximum working height, the amber caution LED will illuminate and the alarm will sound. The display will alternate between “SASH HIGH” and the face velocity to warn that containment levels and airflow velocities are compromised.

Pressing the “ENTER” Button can mute the alarm. When muted the amber LED will flash and the alarm will reactivate after a time of approximately 5 minutes if the sash is not returned to normal operating height.

When the sash is above the maximum working height and the airflow velocity drops below 0.39m/sec, the “AIR FAIL” alarm will trigger and both the amber & red LEDs will flash. Again, the alarm can be muted for a short period.

The display will alternate between face velocity, “SASH HIGH” face velocity and “AIR FAIL”.

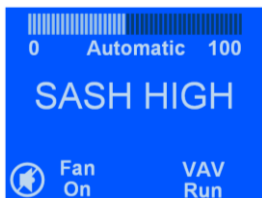

Sash above maximum working height  
A message is displayed



Sash above maximum working height  
Amber LED illuminates



Sash above maximum working height with low airflow  
Messages will alternate



Sash above maximum working height with low airflow  
Both the amber & red LEDs will illuminate

#### 4.8. VAV DAMPER OVERRIDE

On a VAV Fume Cupboard it is possible to override the extract damper by using Button III.

Pressing Button III once will switch from VAV Run to VAV Max, this will open the damper fully to increase the airflow velocity through the Fume Cupboard for a set time.

Pressing Button III again will switch from VAV Max to VAV Min, this will close the damper and decrease the airflow velocity through the Fume Cupboard

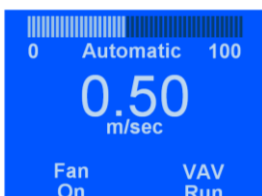

VAV Run  
Default setting: The damper will adjust automatically to maintain the airflow velocity

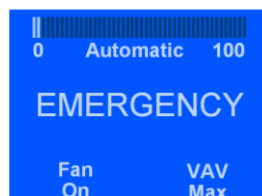

VAV Max  
Purge: Damper fully open for maximum airflow extract in the event of a spillage/emergency



VAV Min  
Reduced velocity: Damper closes to reduce airflow - sometime required for powder work

## 5. SECTION 5

### 5.1. LIGHT SWITCH

The light switch is located on the left-hand aerofoil, immediately above the services panel, and is a switched fuse spur (see page 11 item 3).

If the fuse blows, it needs to be replaced by a 3A BS1363 fuse.

### 5.2. ELECTRICAL SOCKETS *(Optional)*

Up to 2 x double sockets can be located on each aerofoil (see page 11 item 5)

### 5.3. SERVICES *(Optional)*

As per customers' specifications

### 5.4. PIR SENSOR *(Optional)*

The operator sensor is a Passive Infra-Red (PIR) occupancy detector which detects the presence or absence of the Fume Cupboard operator. If the sash is open with no operator present, after a set time (default 5 min) the alarm will sound and "CLOSE SASH" will be displayed. The alarm will stop sounding when the operator returns.

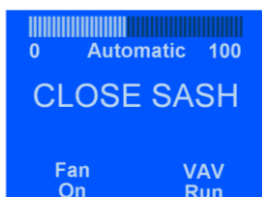

The display will alternate between "CLOSE SASH" and the airflow velocity reading. The alarm will sound and the red LED flashes.

On power up, the PIR Sensor 'learns' the reflection characteristics of the environment within its field of view and stores this information as reference background data. The sensor then 're-learns' the background every three minutes, so that if a stationary object, such as a stool, is left in the field it will become part of the background and 'ignored' by the sensor.

## 6. SECTION 6

### 6.1. WIRING DIAGRAMS

Please note that only the standard unit wiring diagrams are shown here, if further information is required please contact Safelab Systems Ltd.

#### Main circuit with sockets

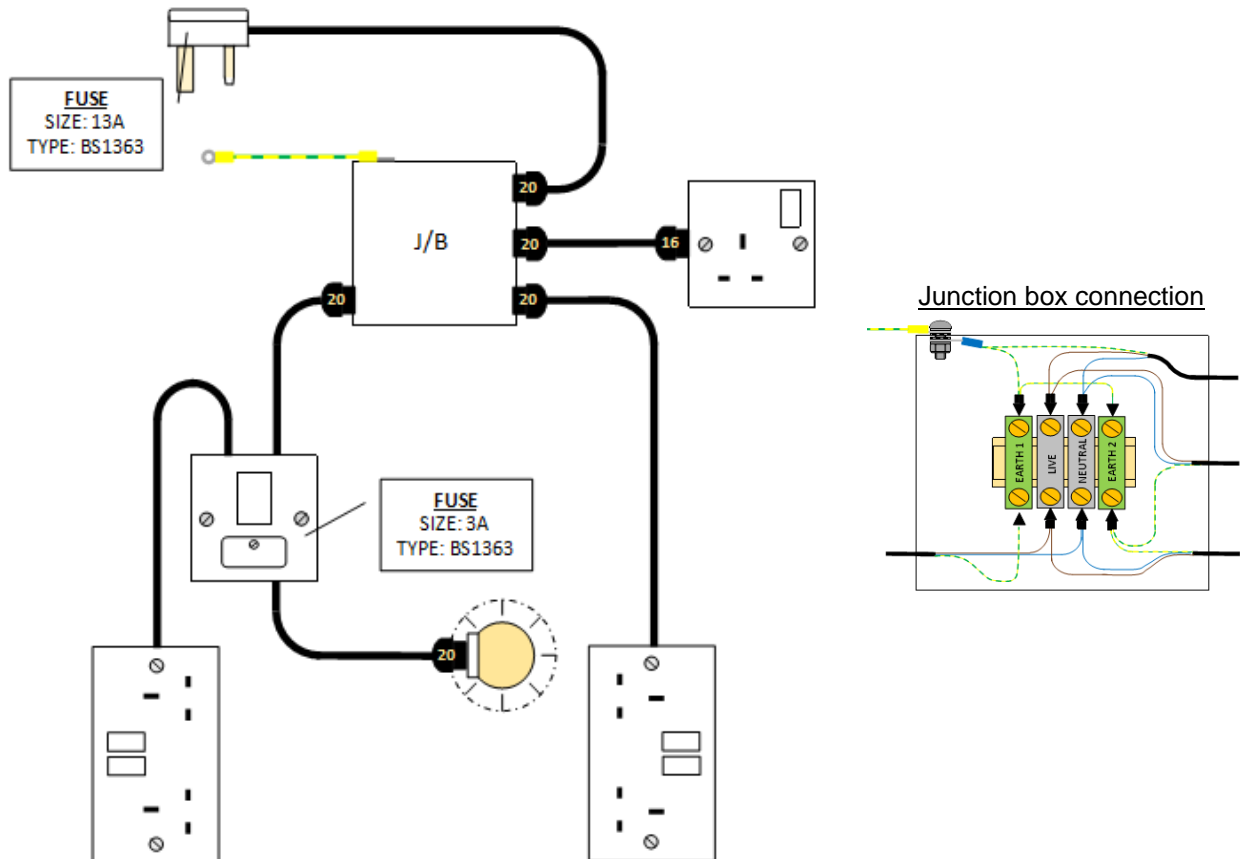

Control panel

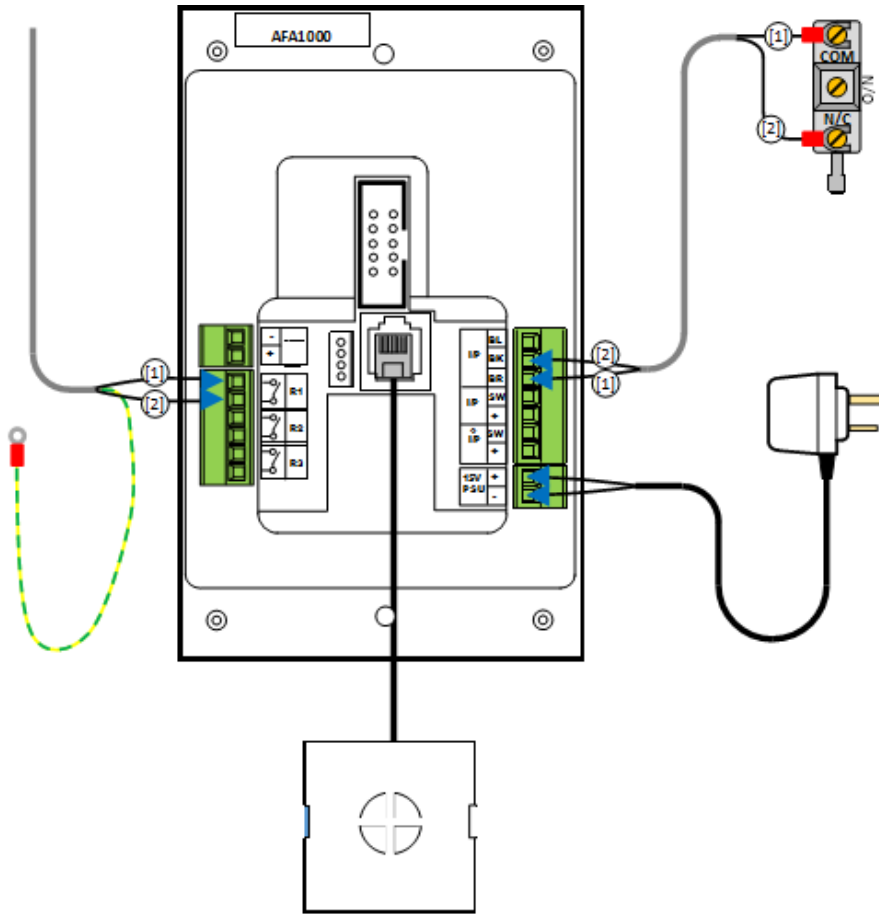

Inverter (where applicable)

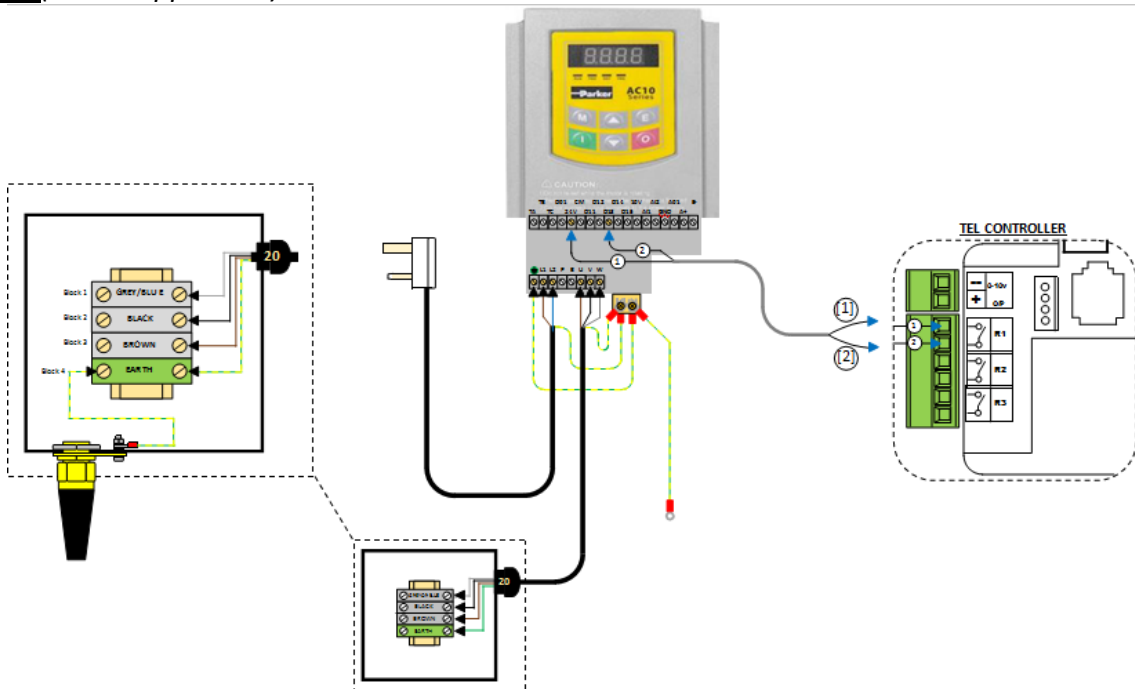

## 6.2. MAINTENANCE AND PERFORMANCE MONITORING:

SHOULD ONLY BE UNDERTAKEN BY A SUITABLY COMPETENT AND QUALIFIED PERSON

 <b>WARNING</b>	Isolate the electrical supply before removing any cover or panel.
---	---

We recommend that a service programme is arranged with Safelab Systems Ltd.

**Regular maintenance by our qualified personnel will ensure safe running of your equipment and also ensure that you meet your requirements under COSHH regulation 9.**

The minimum requirement to comply with COSHH Regulations is that the face velocities must be monitored (at least once every 14 months) and a written record kept of the results. Tables printed on the back pages of the Operational Safety Log-Book are suitable for keeping these records.

### Six Monthly Maintenance

- a) Remove the rear and top baffles from their retaining lugs and clean both the baffle and the rear chamber
- b) Wipe the interior surface of the chamber with a damp cloth of diluted detergent solution
- c) Inspect the sash mechanism for corrosion and damage, lubricate pulley with light machine oil or silicone spray

### Twelve Monthly Maintenance

- a) Items a) to c) as above
- b) Check the condition of the services to the Fume Cupboard, including their service valves, check bedding of sinks and drip cups for signs of leaking, remake joints and test where required
- c) Check the functions of the sash stop and the alarm mechanism
- d) Carry out face velocity checks across the open area of the sash at the normal working height in accordance with BS EN14175-3, 5.2.1.1 and 5.2.2)
 

Using a 100mm dia. vane anemometer, readings should be taken at each of these grid positions and each point should not be any more or less than 20% of the design velocity

Record the mean velocity and update your record accordingly in line with COSHH requirements
- e) Inspect the fire damper(s) (where fitted) and the release mechanism
- f) Inspect the condition of the extract ducting, particularly the joints
- g) Check the stability and condition of the discharge stack

If the Fume Cupboard is frequently used for substantial quantities of corrosive substances, the six-monthly checks should be carried out monthly, and the twelve-monthly checks every six months.

Safelab Systems Ltd offer Service Contracts for regular servicing, for further details please contact our Service department

mailto: [service@safelab.co.uk](mailto:service@safelab.co.uk)

Phone: 01934 421340

### 6.3. SPILLAGES

In the event of a spillage, close the sash to increase containment and follow your standard operating procedures (SOP).

### 6.4. SPARES PARTS

ITEM	UNIT	PART N°
Light fitting	1.2 & 1.5	050228
Light tubes	1.2 & 1.5	050229
Light fitting c/w LED tubes	1.8 & 2.0	050223
Sash black D handle	ALL	130416
Sash stop plunger	ALL	130219
Sash micro switch	ALL	050703





**6.5. NOTES (left blank for notes)**



## 7. CERTIFICATE OF CONFORMITY



### Safelab Systems Ltd

Airone Building  
8 Beaufighter Road  
Weston-Super-Mare  
BS24 8EE  
Tel: + 44 (0) 1934 421 340  
E-mail address: safelab@safelab.co.uk  
www.safelab.co.uk



### UK DECLARATION OF CONFORMITY

#### Safelab Systems Ltd

hereby certify that the

#### **Airone XP4 Ducted Fume Cupboard**

Conforms to the requirements of the  
Electrical Equipment (Safety) Regulations 2016  
Electromagnetic Compatibility Regulation 2016

Complying with the conformity criteria of:

EN 61010-1: 2010 + A2: 2019 Safety requirements for electrical equipment for measurement,  
control and laboratory use Part 1 : General requirements of  
BS EN61326-1: 2020

Signed: 

Roger Guess, Manager Director  
Safelab Systems Ltd

Dated: 20<sup>th</sup> May 2021

---

The single source for the complete clean air solution

---

Registered No: 5336826 England and Wales  
Registered Office: Airone Building, 8 Beaufighter Road, Weston-Super-Mare BS24 8EE

DOCUMENT NO: P131 ISSUE NO: 01 CREATED: 20/05/2021